

CONSTRUCTION

- * Three piece unit : body, nut and sleeve
- * Straight body manufactured from cold drawn 12L14 bar stock , forged body from 12L14 steel , nuts are cold formed C1110 steel (3/8"/1/2"/5/8"/3/4"/1" OD) or from cold drawn 12L14 bar stock . Tube sleeves manufactured from cold drawn 12L14 bar stock and are heat treated .
- * Zinc dichromate plating
- * In the stainless steel version (available on request – series C9) , fittings are manufactured in 316 st/st , with 17-4PH flareless sleeves .

ADVANTAGES

- * Suitable for high pressure hydraulic applications
- * Low cost
- * Wide range of styles and sizes
- * Stainless steel version available on request (C9)
- * C6 & C9 series fittings meet SAE J514 and MS

APPLICATION

- * For use in construction machinery, textile machinery, machine tools, chemical, marine, military and in the most of other high pressure hydraulic applications. Flareless fittings are NOT recommended for use in instrumentation applications where toxic and noxious gases are present.
- * Working pressure up to 8000psi depending on tube and fitting size (and of course on the application).

ORDERING INFORMATION

- * Fitting is supplied as an assembly. If the body only is desired, use the suffix 'BO'.
- * Nomenclature example:

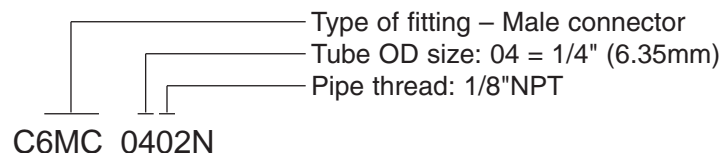

NOTES

- * Non stock items and special parts are available on a quotation basis
- * Configurations and dimensions are subject to change without notice

C6S SLEEVE REF SAE 080115A

PART NUMBER	O.D. TUBE	L
C6S02	1/8" (3.18mm)	0.29"
C6S03	3/16" (mm)	0.33"
C6S04	1/4" (6.35mm)	0.36"
C6S05	5/16" (mm)	0.37"
C6S06	3/8" (9.52mm)	0.38"
C6S08	1/2" (12.70mm)	0.43"
C6S10	5/8" (15.89mm)	0.44"
C6S12	3/4" (19.05mm)	0.48"
C6S14	7/8" (22.22mm)	0.48"
C6S16	1" (25.4mm)	0.48"
C6S20	1 1/4" (31.75mm)	0.48"
C6S24	1 1/2" (38.10mm)	0.48"
C6S32	2" (50.80mm)	0.51"

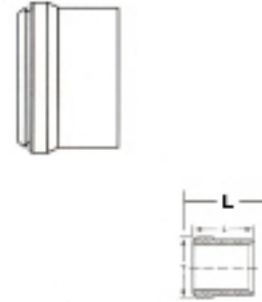

C6N NUT REF SAE 080110

PART NUMBER	O.D. TUBE	HEX C	L	D
C6N02	1/8" (3.18mm)	3/8"	0.53"	0.130"
C6N03	3/16" (4.76mm)	7/16"	0.61"	0.200"
C6N04	1/4" (6.35mm)	9.16"	0.70"	0.260"
C6N05	5/16" (7.94mm)	5/8"	0.72"	0.320"
C6N06	3/8" (9.52mm)	11/16"	0.75"	0.380"
C6N08	1/2" (12.70mm)	7/8"	0.84"	0.510"
C6N10	5/8" (15.89mm)	1"	0.92"	0.630"
C6N12	3/4" (19.05mm)	1 1/4"	0.97"	0.760"
C6N14	7/8" (22.22mm)	1 3/8"	1.00"	0.880"
C6N16	1" (25.4mm)	1 1/2"	1.05"	1.010"
C6N20	1 1/4" (31.75mm)	2"	1.05"	1.260"
C6N24	1 1/2" (38.10mm)	2 1/4"	1.03"	1.510"
C6N32	2" (50.80mm)	2 7/8"	1.12"	2.010"



C6RA REDUCING ADAPTOR REF SAE 080123

PART NUMBER	BODY SIZE	O.D. TUBE	HEX C	L	D
C6RA0604	3/8" (9.52mm)	1/4" (6.35mm)	1/2"	1.61"	0.250"
C6RA0804	1/2" (12.70mm)	1/4" (6.35mm)	9/16"	1.73"	0.375"
C6RA0806	1/2" (12.70mm)	3/8" (9.52mm)	5/8"	1.77"	0.375"
C6RA1008	5/8" (15.89mm)	1/2" (12.70mm)	13/16"	1.96"	0.500"
C6RA1206	3/4" (19.05mm)	3/8" (9.52mm)	13/16"	1.93"	0.625"
C6RA1208	3/4" (19.05mm)	1/2" (12.70mm)	13/16"	2.03"	0.625"
C6RA1612	1" (25.4mm)	3/4" (19.05mm)	1 1/8"	2.24"	0.844"
C6RA2016	1 1/4" (31.75mm)	1" (25.4mm)	1 3/8"	2.28"	1.031"
C6RA2412	1 1/2" (38.10mm)	1 1/2" (38.10mm)	1 5/8"	2.45"	1.250"

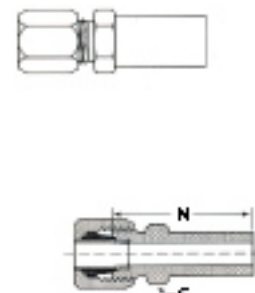

C6U UNION REF SAE 080101

PART NUMBER	O.D. TUBE	O.D. TUBE	HEX C	D	D1	L
C6U02	1/8" (3.18mm)	1/8" (3.18mm)	7/16"	0.093"		1.02"
C6U03	3/16" (mm)	3/16" (4.76mm)	7/16"	0.125"		1.11"
C6U04	1/4" (6.35mm)	1/4" (6.35mm)	1/2"	0.203"		1.18"
C6U05	5/16" (mm)	5/16" (7.94mm)	9/16"	0.234"		1.18"
C6RU0604	3/8" (9.52mm)	1/4" (6.35mm)	5/8"	0.281"	0.203"	1.22"
C6U06	3/8" (9.52mm)	3/8" (9.52mm)	5/8"	0.281"		1.24"
C6U08	1/2" (12.70mm)	1/2" (12.70mm)	13/16"	0.422"		1.42"
C6U10	5/8" (15.89mm)	5/8" (15.89mm)	15/16"	0.500"		1.61"
C6U12	3/4" (19.05mm)	3/4" (19.05mm)	1 1/8"	0.656"		1.81"
C6U14	7/8" (22.22mm)	7/8" (22.22mm)	1 1/4"	0.718"		1.81"
C6U16	1" (25.4mm)	1" (25.4mm)	1 3/8"	0.875"		1.81"
C6U20	1 1/4" (31.75mm)	1 1/4" (31.75mm)	1 11/16"	1.093"		1.89"
C5U24	1 1/2" (38.10mm)	1 1/2" (38.10mm)	2"	1.344"		1.96"
C6U32	2" (50.80mm)	2" (50.80mm)	2 5/8"	1.813"		2.11"

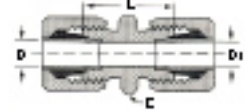

C6UT UNION TEE REF SAE 080401

PART NUMBER	O.D. TUBE	RED O.D. TUBE	D	D1	M	N
C6UT02	1/8" (3.18mm)		0.094"		0.77"	
C6UT03	3/16" (mm)		0.125"		0.84"	
C6UT04	1/4" (6.35mm)		0.203"		0.89"	
C6UT05	5/16" (mm)		0.234"		0.95"	
C6UT06	3/8" (9.52mm)		0.281"	0.281"	1.05"	1.140"
C6RUT0806	1/2" (12.70mm)	3/8" (9.52mm)	0.422"		1.25"	
C6UT08	1/2" (12.70mm)		0.422"		1.25"	
C6UT10	5/8" (15.89mm)		0.500"		1.42"	
C6UT12	3/4" (19.05mm)		0.656"		1.58"	
C6UT14	7/8" (22.22mm)		0.718"		1.62"	
C6UT16	1" (25.4mm)		0.875"		1.73"	

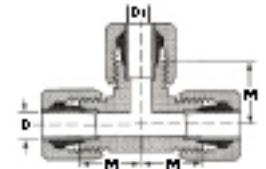
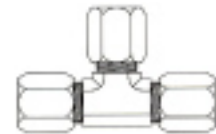

C6MBT MALE BRANCH TEE REF SAE 080425

PART NUMBER	O.D. TUBE	NPT PIPE THREAD	D	D1	M	N
C1MBT0402N	1/4" (6.35mm)	1/8"	0.203"	0.188"	0.89"	0.78"
C1MBT0404N	1/4" (6.35mm)	1/4"	0.203"	0.281"	1.03"	1.09"
C1MBT0502N	5/16" (mm)	1/8"	0.234"	0.188"	0.95"	0.78"
C1MBT0604N	3/8" (9.52mm)	1/4"	0.281"	0.281"	1.05"	1.09"
C1MBT0806N	1/2" (12.70mm)	3/8"	0.422"	0.406"	1.25"	1.22"
C1MBT0808N	1/2" (12.70mm)	1/2"	0.422"	0.531"	1.35"	1.47"
C1MBT1008N	5/8" (15.89mm)	1/2"	0.500"	0.531"	1.42"	1.47"
C1MBT1212N	3/4" (19.05mm)	3/4"	0.656"	0.719"	1.58"	1.59"
C1MBT1616N	1" (25.4mm)	1"	0.875"	0.938"	1.73"	1.97"

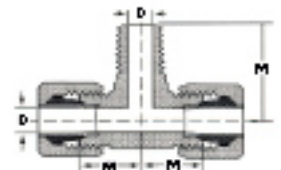
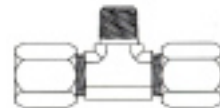

C6MRT MALE RUN TEE REF SAE 080424

PART NUMBER	O.D. TUBE	NPT PIPE THREAD	D	D1	M	N
C1MRT0402N	1/4"(6.35mm)	1/8"	0.203"	0.188"	0.89"	0.78"
C1MRT0404N	1/4"(6.35mm)	1/4"	0.203"	0.281"	1.03"	1.09"
C1MRT0604N	3/8"(9.52mm)	1/4"	0.281"	0.281"	1.05"	1.09"
C1MRT0606N	1/2"(12.70mm)	3/8"	0.422"	0.406"	1.25"	1.22"
C1MRT0808N	1/2"(12.70mm)	1/2"	0.422"	0.531"	1.35"	1.47"
C1MRT1008N	5/8"(15.89mm)	1/2"	0.500"	0.531"	1.42"	1.47"
C1MRT1212N	3/4"(19.05mm)	3/4"	0.656"	0.719"	1.58"	1.59"
C1MRT1616N	1"(25.4mm)	1"	0.875"	0.938"	1.73"	1.97"

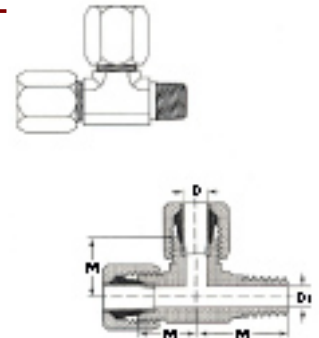

C6FBT FEMALE BRANCH TEE REF SAE 080427

PART NUMBER	O.D. TUBE	NPT PIPE THREAD	D	D1	M	N
C6FBT0402N	1/4"(6.35mm)	1/8"	0.203"	0.332"	0.89"	0.66"
C6FBT0404N	1/4"(6.35mm)	1/4"	0.203"	0.437"	1.03"	0.88"
C6FBT0604N	3/8"(9.52mm)	1/4"	0.281"	0.437"	1.05"	0.88"
C6FBT0806N	1/2"(12.70mm)	3/8"	0.422"	0.562"	1.23"	1.02"
C6FBT1008N	5/8"(15.89mm)	1/2"	0.500"	0.703"	1.42"	1.23"
C6FBT1212N	3/4"(19.05mm)	3/4"	0.656"	0.906"	1.58"	1.36"
C6FBT1616N	1"(25.4mm)	1"	0.875"	1.140"	1.73"	1.62"
C6FBT2020N	1 1/4"(31.75mm)	1 1/4"	1.093"	1.484"	2.08"	1.70"

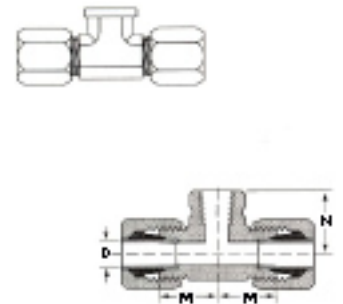

C6FRT FEMALE RUN TEE REF SAE 080426

PART NUMBER	O.D. TUBE	NPT PIPE THREAD	D	D1	M	N
C6FRT0402N	1/4"(6.35mm)	1/8"	0.203"	0.332"	0.89"	0.66"
C6FRT0404N	1/4"(6.35mm)	1/4"	0.203"	0.437"	1.03"	0.88"
C6FRT0604N	3/8"(9.52mm)	1/4"	0.281"	0.437"	1.05"	0.88"
C6FRT0806N	1/2"(12.70mm)	3/8"	0.422"	0.562"	1.23"	1.02"
C6FRT1008N	5/8"(15.89mm)	1/2"	0.500"	0.703"	1.42"	1.23"
C6FRT1212N	3/4"(19.05mm)	3/4"	0.656"	0.906"	1.58"	1.36"
C6FRT1412N	7/8"(22.22mm)	3/4"	0.718"	0.906"	1.62"	1.42"

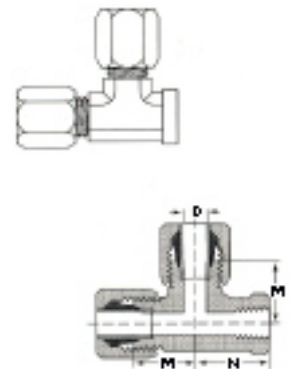

C6BU BULKHEAD UNION REF SAE 080601

PART NUMBER	O.D. TUBE	HEX C	D	L
C6BU0303	3/16"(4.76mm)	5/8"	0.125"	1.80"
C5BU0404	1/4"(6.35mm)	11/16"	0.203"	1.89"
C6BU0606	3/8"(9.52mm)	13/16"	0.281"	1.98"
C6BU0808	1/2"(12.70mm)	1"	0.422"	2.22"
C6BU1212	3/4"(19.05mm)	1 3/8"	0.656"	2.72"
C6BU1414	7/8"(22.22mm)	1 1/2"	0.718"	2.72"
C6BU1616	1"(25.4mm)	1 5/8"	0.875"	2.72"

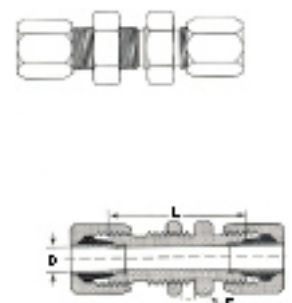

C6UE UNION ELBOW

REF SAE 080201

PART NUMBER	O.D. TUBE	D	M
C6UE04	1/4"(6.35mm)	0.203"	0.89"
C6UE05	5/16"(mm)	0.234"	0.95"
C6UE06	3/8"(9.52mm)	0.281"	1.05"
C6UE08	1/2"(12.70mm)	0.422"	1.25"
C6UE10	5/8"(15.89mm)	0.500"	1.42"
C6UE12	3/4"(19.05mm)	0.656"	1.58"
C6UE14	7/8"(22.22mm)	0.718"	1.62"
C6UE16	1"(25.4mm)	0.875"	1.73"
C6UE20	1 1/4"(31.75mm)	1.093"	1.89"



C6FC FEMALE CONNECTOR

REF SAE 080103

PART NUMBER	O.D. TUBE	NPT PIPE THREAD	HEX C	D	D1	L
C6FC0202N	1/8" (3.18mm)	1/8"	9/16"	0.093"	0.332"	1.05"
C6FC0402N	1/4"(6.35mm)	1/8"	9/16"	0.203"	0.332"	1.09"
C6FC0404N	1/4"(6.35mm)	1/4"	3/4"	0.203"	0.437"	1.29"
C6FC0502N	5/16"(7.94mm)	1/8"	9/16"	0.234"	0.332"	1.08"
C6FC0604N	3/8"(9.52mm)	1/4"	3/4"	0.281"	0.437"	1.31"
C6FC0606N	3/8"(9.52mm)	3/8"	7/8"	0.281"	0.562"	1.36"
C6FC0804N	1/2"(12.70mm)	1/4"	7/8"	0.422"	0.437"	1.32"
C6FC0806N	1/2"(12.70mm)	3/8"	7/8"	0.422"	0.562"	1.47"
C6FC0808N	1/2"(12.70mm)	1/2"	1 1/8"	0.422"	0.703"	1.63"
C6FC1008N	5/8"(15.89mm)	1/2"	1 1/8"	0.500"	0.703"	1.76"
C6FC1212N	3/4"(19.05mm)	3/4"	1 3/8"	0.656"	0.906"	1.89"
C6FC1412N	7/8"(22.22mm)	3/4"	1 3/8"	0.718"	0.906"	1.86"
C6FC1616N	1"(25.4mm)	1"	1 5/8"	0.875"	1.140"	2.13"
C6FC2020N	1 1/4"(31.75mm)	1 1/4"	2"	1.093"	1.484"	2.22"

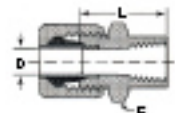
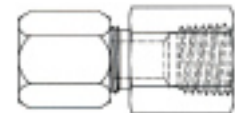

C6FE 90° FEMALE ELBOW

REF SAE 080203

PART NUMBER	O.D. TUBE	NPT PIPE THREAD	D	D1	M	N
C6FE0402N	1/8" (3.18mm)	1/8"	0.203"	0.332"	0.89"	0.66"
C6FE0404N	1/4"(6.35mm)	1/4"	0.203"	0.437"	1.03"	0.88"
C6FE0502N	5/16"(7.94mm)	1/8"	0.234"	0.332"	0.95"	0.66"
C6FE0604N	3/8"(9.52mm)	1/4"	0.281"	0.437"	1.05"	0.88"
C6FE0606N	3/8"(9.52mm)	3/8"	0.281"	0.562"	1.12"	0.88"
C6FE0806N	1/2"(12.70mm)	3/8"	0.422"	0.562"	1.23"	1.02"
C6FE0808N	1/2"(12.70mm)	1/2"	0.422"	0.703"	1.35"	1.23"
C6FE1008N	5/8"(15.89mm)	1/2"	0.500"	0.703"	1.42"	1.23"
C6FE1212N	3/4"(19.05mm)	3/4"	0.656"	0.906"	1.58"	1.36"
C6FE1412N	7/8"(22.22mm)	3/4"	0.718"	0.906"	1.62"	1.42"
C6FE1616N	1"(25.4mm)	1"	0.875"	1.140"	1.73"	1.62"

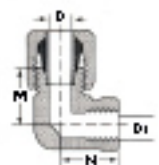

C6MC MALE CONNECTOR

REF SAE 080102

PART NUMBER	O.D. TUBE	NPT PIPE THREAD	HEX C	D	D1	L
C6MC0202N	1/8" (3.18mm)	1/8"	7/16"	0.093"	0.188"	1.04"
C6MC0204N	1/8" (3.18mm)	1/4"	9/16"	0.093"	0.281"	1.25"
C6MC0302N	3/16" (4.76mm)	1/8"	7/16"	0.125"	0.188"	1.09"
C6MC0402N	1/4" (6.35mm)	1/8"	1/2"	0.203"	0.188"	1.12"
C6MC0404N	1/4" (6.35mm)	1/4"	9/16"	0.203"	0.281"	1.32"
C6MC0406N	1/4" (6.35mm)	3/8"	3/4"	0.203"	0.406"	1.33"
C6MC0408N	1/4" (6.35mm)	1/2"	7/8"	0.203"	0.531"	1.58"
C6MC0502N	5/16" (7.94mm)	1/8"	9/16"	0.234"	0.188"	1.12"
C6MC0504N	5/16" (7.94mm)	1/4"	9/16"	0.234"	0.281"	1.32"
C6MC0602N	3/8" (9.52mm)	1/8"	5/8"	0.281"	0.188"	1.15"
C6MC0604N	3/8" (9.52mm)	1/4"	5/8"	0.281"	0.281"	1.34"
C6MC0606N	3/8" (9.52mm)	3/8"	3/4"	0.281"	0.406"	1.35"
C6MC0608N	3/8" (9.52mm)	1/2"	7/8"	0.281"	0.531"	1.60"
C6MC0804N	1/2" (12.70mm)	1/4"	13/16"	0.422"	0.281"	1.44"
C6MC0806N	1/2" (12.70mm)	3/8"	13/16"	0.422"	0.406"	1.44"
C6MC0808N	1/2" (12.70mm)	1/2"	7/8"	0.422"	0.531"	1.69"
C6MC0812N	1/2" (12.70mm)	3/4"	1-1/8"	0.422"	0.719"	1.76"
C6MC1006N	5/8" (15.89mm)	3/8"	15/16"	0.500"	0.406"	1.56"
C6MC1008N	5/8" (15.89mm)	1/2"	15/16"	0.500"	0.531"	1.75"
C6MC1208N	3/4" (19.05mm)	1/2"	1 1/8"	0.656"	0.531"	1.88"
C6MC1212N	3/4" (19.05mm)	3/4"	1 1/8"	0.656"	0.719"	1.88"
C6MC1412 N	7/8" (22.22mm)	3/4"	1 1/4"	0.718"	0.719"	1.88"
C6MC1612N	1" (25.4mm)	3/4"	1 3/8"	0.875"	0.719"	1.88"
C6MC1616N	1" (25.4mm)	1"	1 3/8"	0.875"	0.938"	2.07"
C6MC2020N	1 1/4" (31.75mm)	1 1/4"	1 11/16"	1.093"	1.250"	2.18"
C6MC2424N	1 1/2" (38.10mm)	1 1/2"	2"	1.334"	1.500"	2.28"
C6MC3232N	2" (50.80mm)	2"	2 5/8"	1.813"	1.938"	2.46"

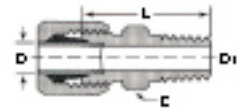

C6UC UNION CROSS

REF SAE 080501

PART NUMBER	O.D. TUBE	D	M
C6UC04	1/4" (6.35mm)	0.203"	0.89"
C6UC06	3/8" (9.52mm)	0.281"	1.05"
C6UC08	1/2" (12.70mm)	0.422"	1.25"
C6UC10	5/8" (15.89mm)	0.500"	1.42"

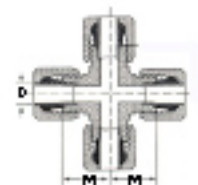

C6ME MALE ELBOW REF SAE 080202

PART NUMBER	O.D. TUBE	NPT PIPE THREAD	D	D1	M	N
C6ME0202N	1/8" (3.18mm)	1/8"	0.093"	0.188"	0.77"	0.72"
C6ME0302N	3/16"(4.76mm)	1/8"	0.125"	0.188"	0.83"	0.72"
C6ME0402N	1/4"(6.35mm)	1/8"	0.203"	0.188"	0.89"	0.78"
C6ME0404N	1/4"(6.35mm)	1/4"	0.203"	0.281"	1.03"	1.09"
C6ME0502N	5/16"(7.94mm)	1/8"	0.234"	0.188"	0.95"	0.78"
C6ME0504N	5/16"(7.94mm)	1/4"	0.234"	0.281"	1.03"	1.09"
C6ME0602N	3/8"(9.52mm)	1/8"	0.281"	0.188"	1.05"	0.90"
C6ME0604N	3/8"(9.52mm)	1/4"	0.281"	0.281"	1.05"	1.09"
C6ME0606N	3/8"(9.52mm)	3/8"	0.281"	0.406"	1.14"	1.22"
C6ME0608N	3/8"(9.52mm)	1/2"	0.281"	0.531"	1.24"	1.47"
C6ME0804N	1/2"(12.70mm)	1/4"	0.422"	0.281"	1.25"	1.22"
C5ME0806N	1/2"(12.70mm)	3/8"	0.422"	0.406"	1.25"	1.22"
C6ME0808N	1/2"(12.70mm)	1/2"	0.422"	0.531"	1.35"	1.47"
C6ME1006N	5/8"(15.89mm)	3/8"	0.500"	0.406"	1.42"	1.28"
C6ME1008N	5/8"(15.89mm)	1/2"	0.500"	0.531"	1.42"	1.47"
C6ME1208N	3/4"(19.05mm)	1/2"	0.656"	0.531"	1.58"	1.59"
C6ME1212N	3/4"(19.05mm)	3/4"	0.656"	0.719"	1.58"	1.59"
C6ME1412N	7/8"(22.22mm)	3/4"	0.718"	0.719"	1.62"	1.69"
C6ME1612N	1"(25.4mm)	3/4"	0.875"	0.719"	1.73"	1.78"
C6ME1616N	1"(25.4mm)	1"	0.875"	0.938"	1.73"	1.97"
C6ME2020N	1 1/4"(31.75mm)	1 1/4"	1.093"	1.250"	1.89"	2.38"
C6ME2424N	1 1/2"(38.10mm)	1 1/2"	1.344"	1.500"	2.02"	2.64"
C6ME3232N	2"(50.80mm)	2"	1.813"	1.938"	2.45"	3.00"

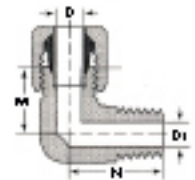

C6ME45 45° MALE ELBOW REF SAE 080302

PART NUMBER	O.D. TUBE	NPT PIPE THREAD	D	D1	M	N
C6ME450402N	1/8" (3.18mm)	1/8"	0.203"	0.188"	0.70"	0.64"
C6ME450404N	1/4"(6.35mm)	1/4"	0.203"	0.281"	0.83"	0.86"
C6ME450502N	5/16"(7.94mm)	1/8"	0.234"	0.188"	0.75"	0.64"
C6ME450604N	3/8"(9.52mm)	1/4"	0.281"	0.281"	0.83"	0.86"
C6ME450806N	1/2"(12.70mm)	3/8"	0.422"	0.406"	0.98"	0.95"
C6ME451008N	5/8"(15.89mm)	1/2"	0.500"	0.531"	1.08"	1.17"
C6ME451212N	3/4"(19.05mm)	3/4"	0.656"	0.719"	1.27"	1.20"
C6ME451414N	7/8"(22.22mm)	7/8"	0.718"	0.719"	1.34"	1.30"
C6ME451616N	1"(25.4mm)	1"	0.875"	0.938"	1.36"	1.48"

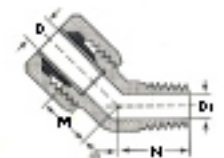

C6BE CAP REF SAE 080112

PART NUMBER	O.D. TUBE	HEX C	L
C6BE04	1/4"(6.35mm)	9.16"	0.70"
C6BE06	3/8"(9.52mm)	11/16"	0.75"
C6BE08	1/2"(12.70mm)	7/8"	0.84"
C6BE10	5/8"(15.89mm)	1"	0.92"
C6BE12	3/4"(19.05mm)	1 1/4"	0.97"
C6BE16	1"(25.4mm)	1 1/2"	1.05"
C6BE20	1 1/4"(31.75mm)	2"	1.05"

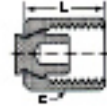
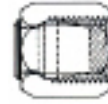

C6BP BLANKING PLUG REF SAE 080109

PART NUMBER	O.D. TUBE	HEX C	L
C6BP02	1/8" (3.18mm)	7/16"	0.63"
C6BP04	1/4"(6.35mm)	1/2"	0.71"
C6BP05	5/16"(7.94mm)	9.16"	0.71"
C6BP06	3/8"(9.52mm)	5/8"	0.75"
C6BP08	1/2"(12.70mm)	13/16"	0.85"
C6BP10	5/8"(15.89mm)	15/16"	0.97"
C6BP12	3/4"(19.05mm)	1 1/8"	1.10"
C6BP16	1"(25.4mm)	1 3/8"	1.10"

