

### SS316L 3/8", 1/2", 3/4" NPT lock-up valves – LK serie

Valvole di lock-up da 3/8", 1/2", 3/4" NPT in AISI316L – serie LK

www.sitecna.eu

- Suitable for automation equipment to onshore, offshore, pharmaceutical, medical and food applications
- Full material traceability
- Excellent stability and repeatability
- Accurate adjustment and high flow capacity
- Single or double locking possibility
- ATEX 2014/34/UE II 2G Ex h IIC T6/T5 Gb X  
II 2D Ex h IIC T85°C/T100°C Db X

- Adatto per automazione in applicazioni marine, petrolchimiche, farmaceutiche, medicali e alimentari
- Completa rintracciabilità dei materiali
- Eccellente stabilità e ripetibilità
- Precise regolazioni ed elevate portate
- Possibilità di blocco singolo o doppio
- ATEX 2014/34/UE II 2G Ex h IIC T6/T5 Gb X  
II 2D Ex h IIC T85°C/T100°C Db X

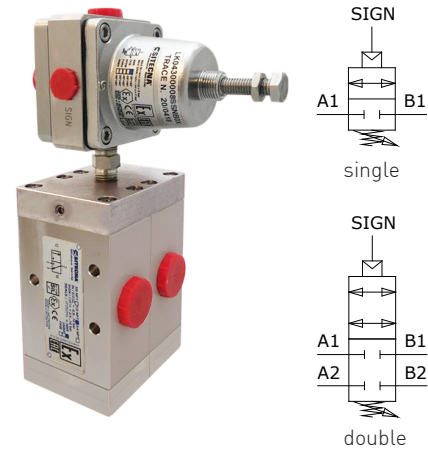

Media / Fluido	Compressed air, inert gases, sweet and sour gases
Port thread / Connessioni	3/8", 1/2", 3/4" NPT
Pilot connection Connessione pilotaggio	1/4" NPT
Signal connection Connessione segnale	1/8" NPT
Working pressure Pressione di lavoro	-0.9 - 10 bar
Max signal/output pressure Pressione massima segnale/uscita	7 bar
Working temperature / Temperatura di esercizio	-20°C up to 80°C (NBR); -25°C up to 90°C (FKM); -40°C up to 80°C (EPDM); -55° up to 90°C (FVMQ)*
Upward adjustment/ Sensibilità in salita	1 bar
Downward adjustment/ Sensibilità in discesa	0,5 bar
Max lock-up pressure Massima pressione di intervento	7 bar

Air supply must be dry enough to avoid ice formation at temperatures below +2°C (+35°F).

**\*Special version in HNBR (WT -55° +90°C)**

**It provides reliable shut down & isolation from control devices of the actuator whenever air pressure falls below operating safety point. Rugged and corrosion-resistant – made in SS316L - Compact small package size – light weight**

Permette affidabile intercettazione ed esclusione dell'attuatore quando la pressione dell'aria scende al di sotto del livello minimo operativo. Robusto e resistente alla corrosione – Costruito completamente in AISI316L - Dimensioni di ingombro ridotte – Leggero

BUILDING MATERIALS	Materiali costruttivi
Body, bonnet, end plate of switch valve, Body, heads of spool valves nipple in AISI316	Corpo, tazza superiore, piattello switch valve, Corpo e testate spool valves. nipplo in AISI316
Internals, lock and panel nuts, fixing screws in stainless steel	Vite di regolazione, dadi di bloccaggio e pannello, viti di fissaggio in acciaio inossidabile
Diaphragms & seals in elastomer	Diaframmi e guarnizioni in elastomero

BT-LKSSL/C20A

## Overall dimension

Dimensioni di ingombro

### Single Lock-up valve

Valvola di Lock-up singola

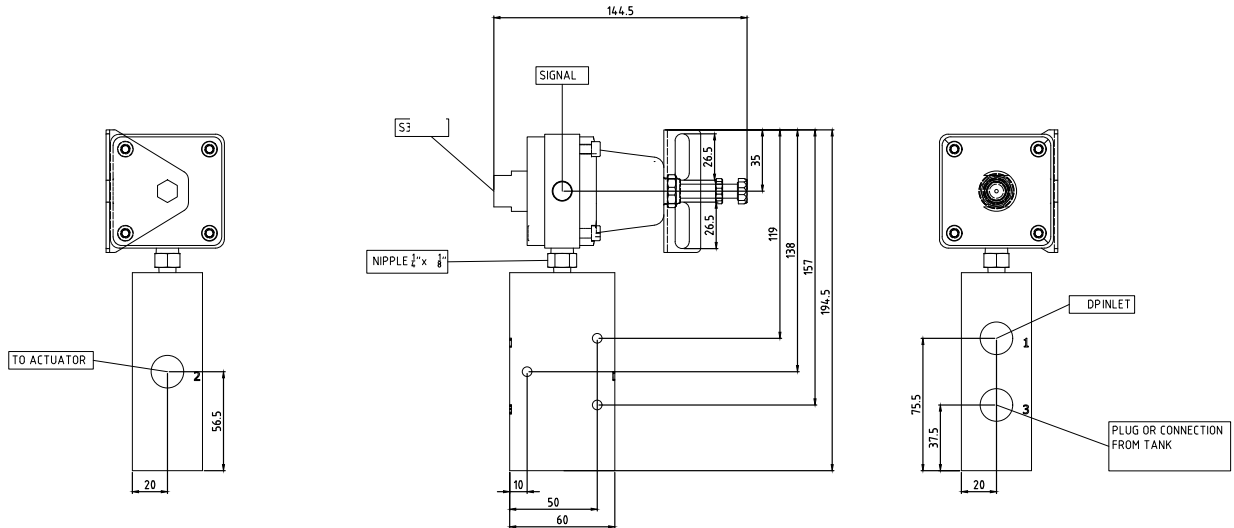

### Double Lock-up valve

Valvola di Lock-up doppia

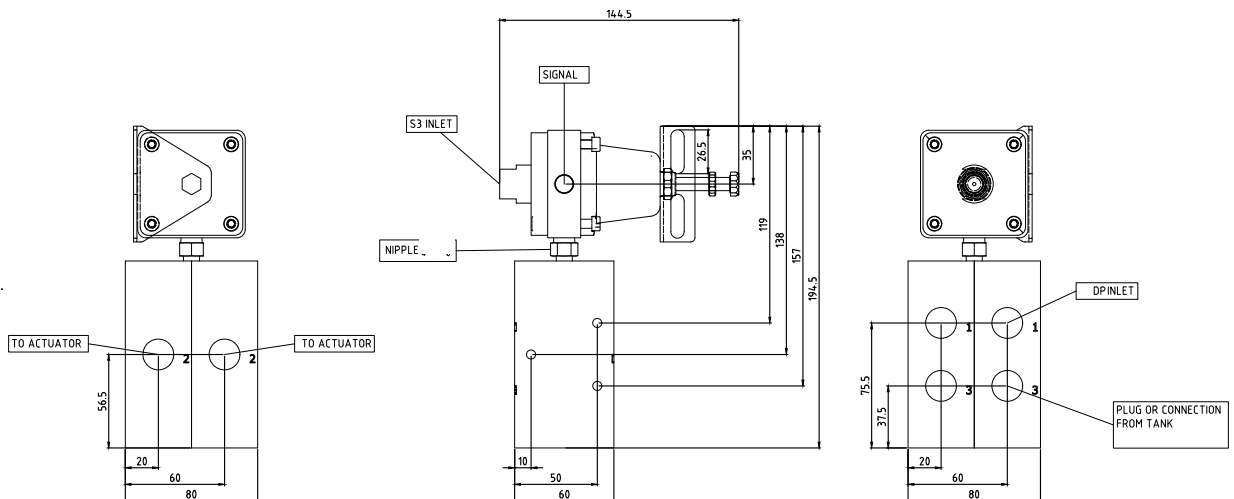

# Application examples for LK08

Esempi di applicazione del LK08

## Single actuating actuator

Attuatore a singolo effetto

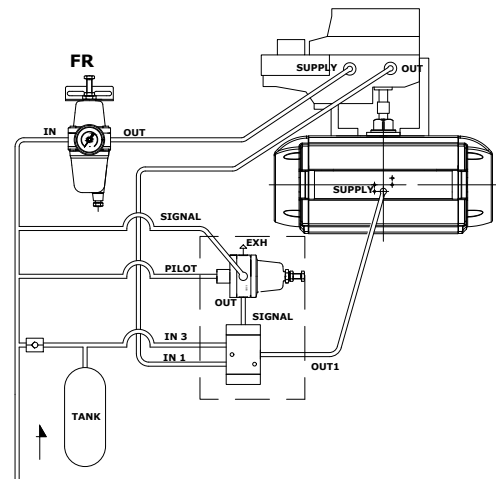
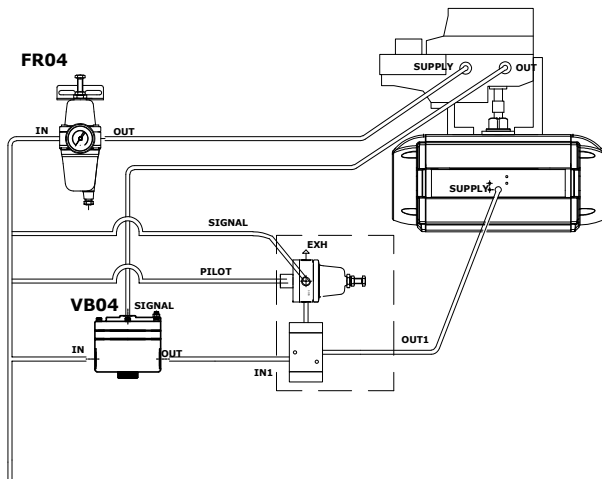

## Double actuating actuator

Attuatore a doppio effetto

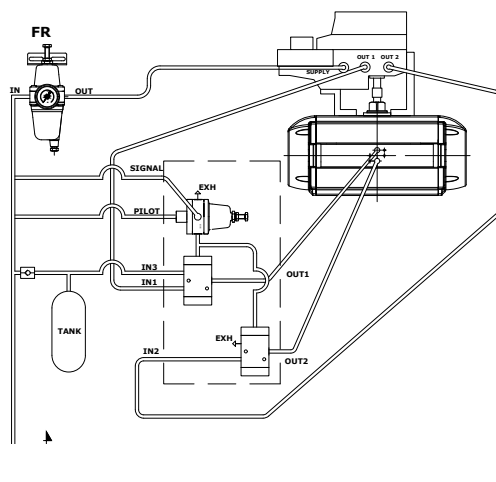
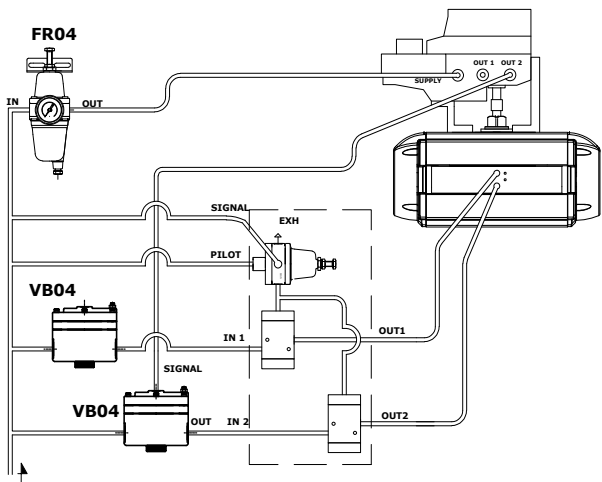

BT-LK4SS/C20C

www.sitecna.eu

# Ordering information

## Come ordinare

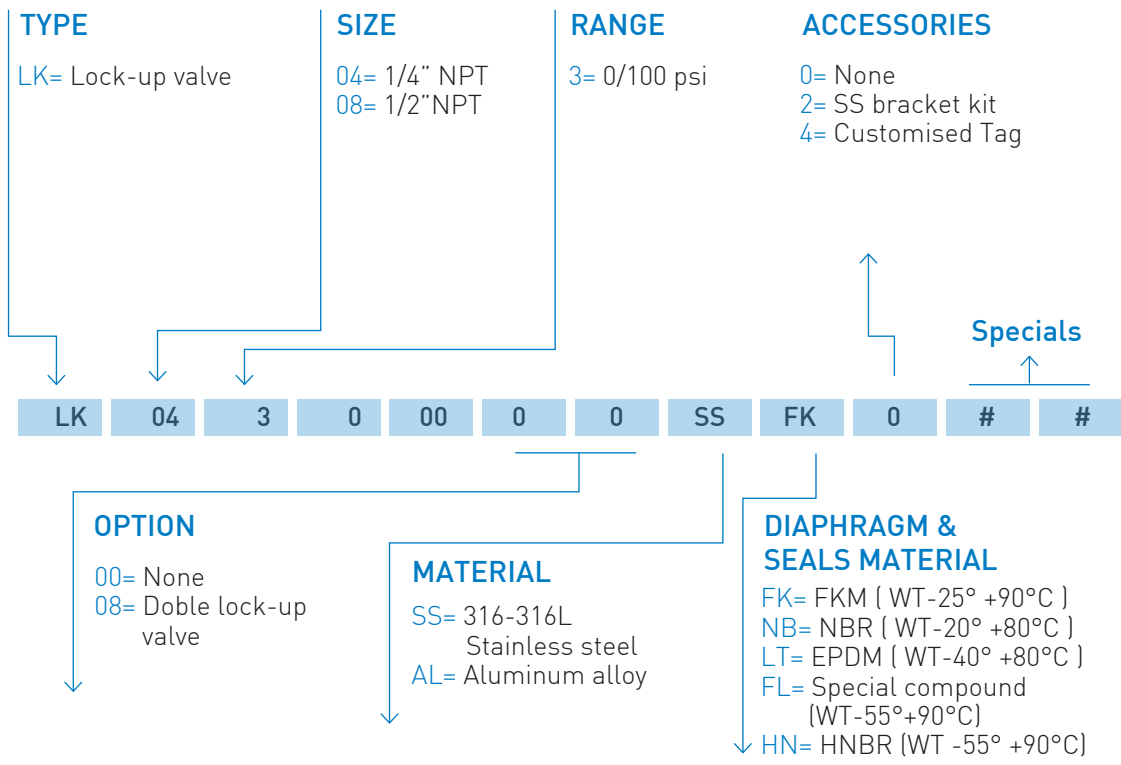

### CODE EXAMPLES

LK	08	3	0	00	0	0	SS	FK	0		
----	----	---	---	----	---	---	----	----	---	--	--

**1/2" NPT, SS316L, Single Lock up valve, with FKM diaphragm & seals, Cv0.9, WT -25°C to 90°C, with SS bracket**

Valvola di lock-up singola da 1/4" NPT in AISI316L con diaframma e tenute in FKM, Cv 0.9, temperatura di lavoro da -25°C a +90°C

LK	04	3	0	00	0	8	AL	LT	2		
----	----	---	---	----	---	---	----	----	---	--	--

**1/4" NPT, Epoxy painted aluminium alloy + SS304 or 316L, Double lock up valve with EPDM diaphragm & seals, CV 0.9, WT -40°C to +80°C, with SS bracket**

Valvola di lock-up doppia da 1/4" NPT in lega di alluminio con verniciatura epossidica + AISI304-316L con diaframma e tenute in EPDM, Cv 0.9, temperatura di lavoro da -40°C a +80°C, con staffa inox



BT-CVCD/C20A