

IN-LINE FLOW CONTROL NEEDLE AND CHECK VALVES – J series

CONSTRUCTION

- * All brass one piece forgings
- * Stainless steel internals (needle , ball , spring)
- * Viton seals standard (NBR seals as an option)
- * Metal to metal check valves seats
- * NPT threads standard (other as an option)

Series

J

ANGLE FLOW CONTROL NEEDLE VALVES – FT125 series

CONSTRUCTION

- * All brass one piece forgings
- * Viton seals standard (NBR seals as an option)
- * NPT threads standard (other as an option)

Series

FT

ADVANTAGES

- * Dual tapered needle provides the highest flow coupled with the most sensitive adjustment from full open to full close
- * 2psi ball check valve cracking pressure (J series)
- * Curled knobs with stop screw
- * Safe working pressure to 3000psi
- * Suitable with oil , air and compatible gases

ORDERING INFORMATION

- * Order using indicated part number
- * Part number indicates style and size

NOTES

- * Non stock items and special parts are available on a quotation basis
- * Configurations and dimensions are subject to change without notice

AJF UNI-DIRECTIONAL INLINE FLOW CONTROL VALVE NPT VITON seals

PART NUMBER	NPT PIPE THREAD	A	B	C	D	E	F	G HEX	CHECK VALVE Cv	FULL OPEN NEEDLE Cv
AJF1/VS	1/8"	37.3	14.3	23.2	45.8	6.35	17.5	3/32"	0.60	0.30
AJF2/VS	1/4"	49.2	17.5	31.3	50.8	6.35	17.5	3/32"	1.30	0.60
AJF3/VS	3/8"	58.7	22.2	39.3	64.3	7.62	23.8	3/32"	2.85	1.08
AJF4/VS	1/2"	82.55	30.2	53.8	81.8	9.53	31.8	3/32"	4.96	1.75
AJF6/VS	3/4"	101.6	44.5	66.7	99.2	9.53	31.8	3/32"	9.00	3.20
AJF8/VS	1"	101.6	44.5	66.9	99.2	9.53	31.8	3/32"	9.20	3.20

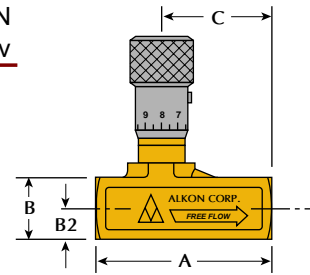

AJN BI-DIRECTIONAL INLINE FLOW CONTROL VALVE NPT VITON seals

PART NUMBER	NPT PIPE THREAD	A	B	C	D	E	F	G HEX	ORIFICE	FULL OPEN NEEDLE Cv
AJN1/VS	1/8"	37.3	14.3	23.2	45.8	6.35	17.5	3/32"	0.125	0.30
AJN2/VS	1/4"	49.2	17.5	31.3	50.8	6.35	17.5	3/32"	0.187	0.60
AJN3/VS	3/8"	58.7	22.2	39.3	64.3	7.62	23.8	3/32"	0.250	1.08
AJN4/VS	1/2"	82.55	30.2	53.8	81.8	9.53	31.8	3/32"	0.375	1.75
AJN6/VS	3/4"	101.6	44.5	66.7	99.2	9.53	31.8	3/32"	0.500	3.20
AJN8/VS	1"	101.6	44.5	66.9	99.2	9.53	31.8	3/32"	0.500	3.20

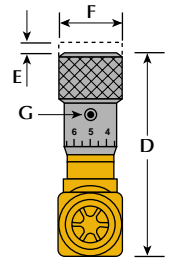

FT1254 UNI-DIRECTIONAL 90° FLOW CONTROL VALVE NPT VITON seals

PART NUMBER	NPT PIPE THREAD	B	C	D	E	F	G	H	L	CH
FT1254/50218NV	1/8"	9	21	69	4	21.5	12	M15x1	9.5	15
FT1254/50214NV	1/4"	12.5	25	74	4.5	21.5	12	M17x1	11	17
FT1254/50238NV	3/8"	13.5	29.5	88	7	26	12.5	M20x1	15	22
FT1254/50212NV	1/2"	15	36	105	10	33	13	M25x1.5	19	27

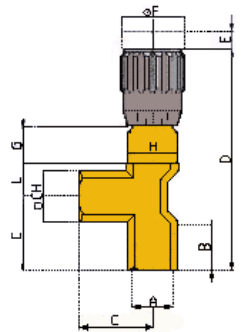

FT1252 BI-DIRECTIONAL 90° FLOW CONTROL VALVE NPT

PART NUMBER	NPT PIPE THREAD	B	C	D	E	F	G	H	L	CH
FT1252/20118NV	1/8"	9	21	69	4	21	40	M15x1	9.5	15
FT1252/20114NV	1/4"	12.5	25	74	4.5	21	40	M17x1	11	17
FT1252/20138NV	3/8"	13.5	29.5	88	7	26	50	M20x1	15	22
FT1252/20112NV	1/2"	15	36	105	10	33	70	M25x1.5	19	27

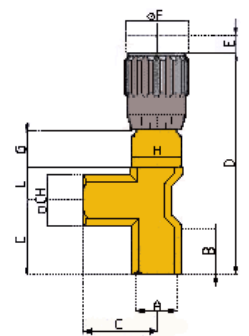

AJC IN-LINE HIGH FLOW CHECK VALVE 2PSI CP

PART NUMBER	NPT PIPE THREAD	A	B	ORIFICE	FULL OPEN CHECK VALVE CV
AJC1	1/8"	37	14.3	5.2	0.64
AJC2	1/4"	49	17.5	7.2	1.35
AJC3	3/8"	59	22.3	10.7	3.22
AJC4	1/2"	83	30.2	13.1	4.96
AJC6N	3/4"	102	44.5	18.2	9.00
AJC8N	1"	102	44.5	18.2	9.20

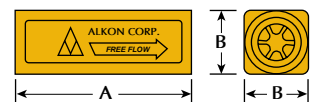

** SIZES EXPRESSED IN MM , UNLESS DIFFERENTLY STATED

SS 316 6000psi Adjustable Check Valves - threaded

WACV ADJUSTABLE MINIATURE CHECK VALVE (1/4", 1/2")

PART NUMBER	NPT PIPE THREAD	L mm	HEX	*CRACKING PRESSURE
WACV2N-*	1/4"	42	0.562"	0 to 150psi
WACV4N-*	1/2"	52	0.875"	0 to 150psi

* add required cracking pressure in BAR (0 to 150 psi springs available)

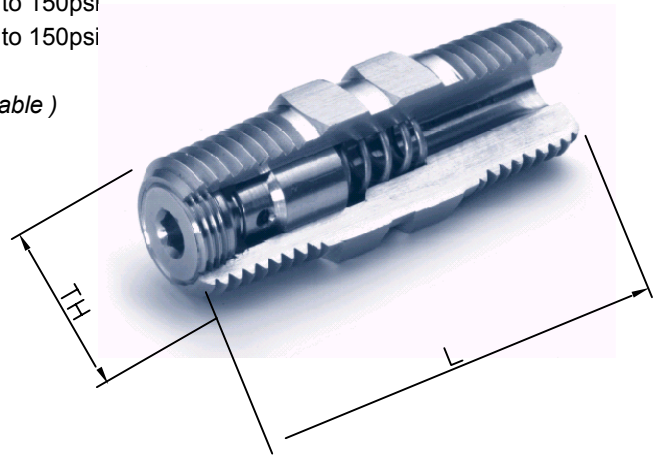

Brass Check Valves - Compression type

C1MCCV CHECK CONNECTOR (OD TUBE 02,04,06 C1 series)

PART NUMBER	O.D. TUBE	NPT PIPE THREAD	A	B	HEX
C1MCCV0202N	1/8"	1/8"	1.10"	0.78"	7/16"
C1MCCV0402N	1/4"	1/8"	1.12"	0.88"	9/16"

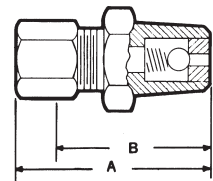

* 4 psi standard cracking pressure
 * NBR70 std O'ring , Viton O'ring available on request

C1MECV CHECK ELBOW (OD TUBE 02 C1 series)

PART NUMBER	O.D. TUBE	NPT PIPE THREAD	A	B	C
C1MECV0202N	1/8"	1/8"	0.79"	0.59"	0.72"

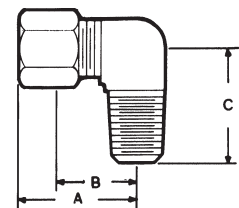

* 4 psi standard cracking pressure
 * NBR70 std O'ring , Viton O'ring available on request